

Varenummer: 20141B45B452BL  
 Beskrivelse: E+G Kryds m/flange  
 GN141-B45-B45-2-BL

## Mål

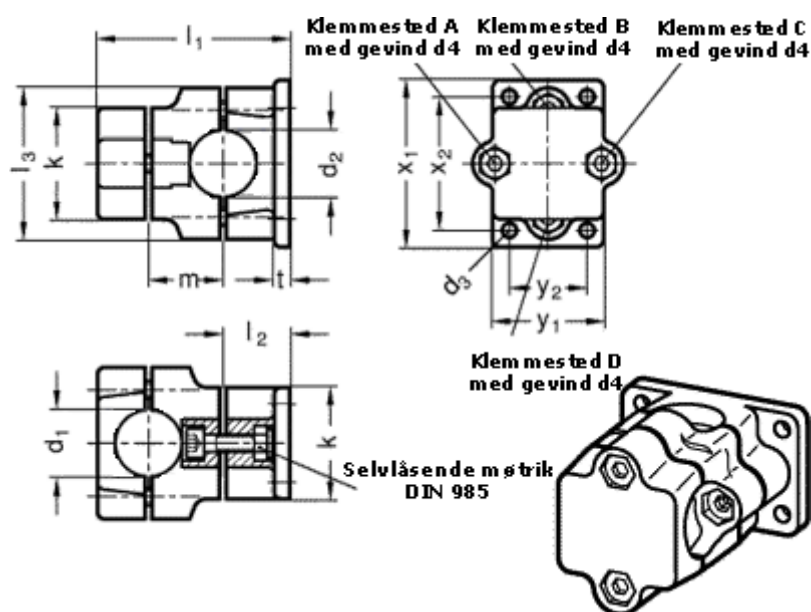

$d_1 = 45$	$m = 55$
$d_2 = 45$	$t = 14$
$d_3 = 11$	Vippehåndtag = GN 911-M10-63 skal bestilles separat
$d_4 = M10$	$x_1 = 115$
$k = 76$	$x_2 = 90$
$l_1 = 136$	$y_1 = 76$
$l_2 = 46$	$y_2 = 50$
$l_3 = 98$	